



Lakelands Concrete Products, Inc.
7520 East Main St., Lima, NY 14485
Phone: 585-624-1990, Fax: 585-624-2102

Web: www.lakelandsconcrete.com
E-mail: sales@lakelandsconcrete.com

Date: 12/15/10

DWG: SP-MB

Median Barrier

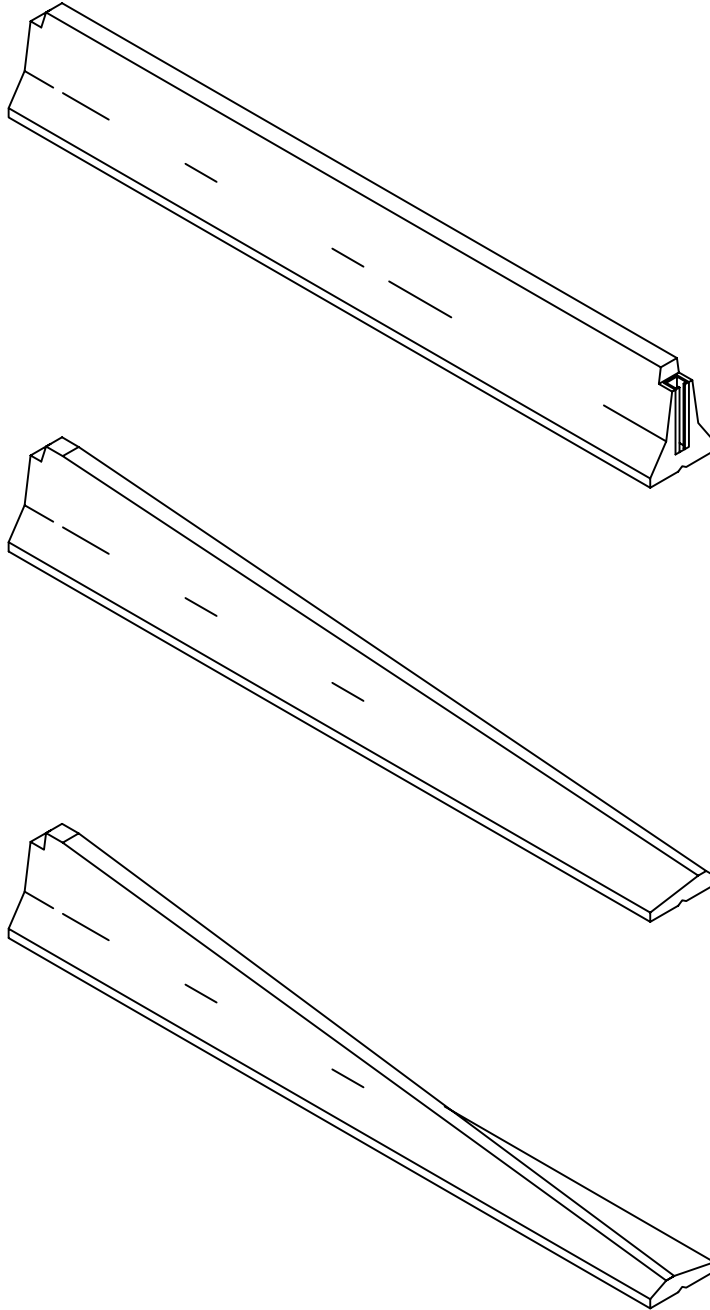



Lakelands Concrete Products, Inc.
 7520 East Main St., Lima, NY 14485
 Phone: 585-624-1990, Fax: 585-624-2102

Web: www.lakelandsconcrete.com
 E-mail: sales@lakelandsconcrete.com

Date: 12/15/10

DWG: SP-MB

Median Barrier

Notes:

- *Meets NYSDOT Item #619.17
- *1 1/4" Dia Holes For 1" Dia Anchor Rods (Alternate Sides)

Specifications:

- Concrete: 5000psi @ 28 Days
- Entrained Air: 5% - 9%
- Reinforcing: BAR-ASTM A615 GR60
WWR-ASTM A185/A497 GR65

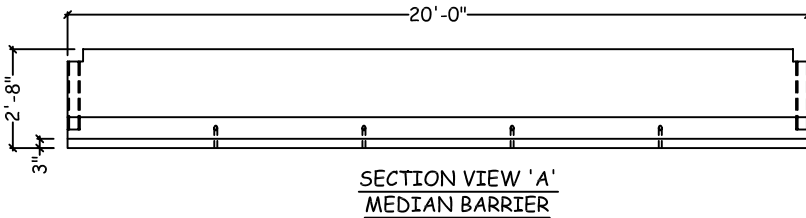
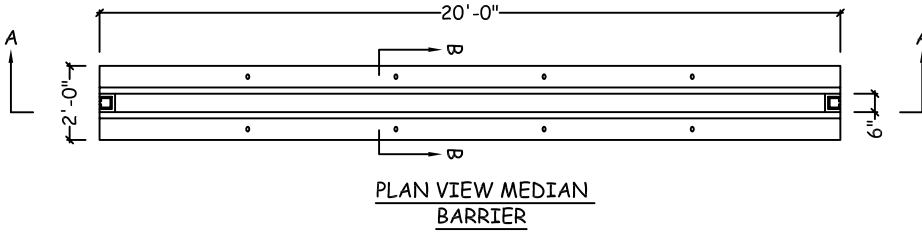

SECTION VIEW 'B' MEDIAN BARRIER
 SP-MB20

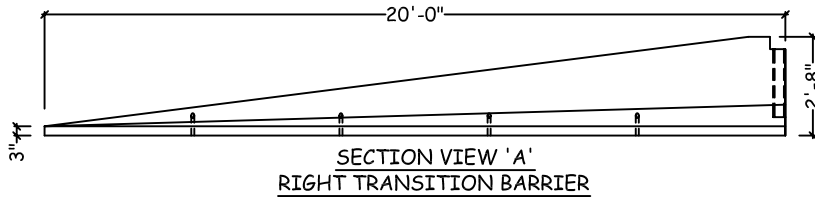
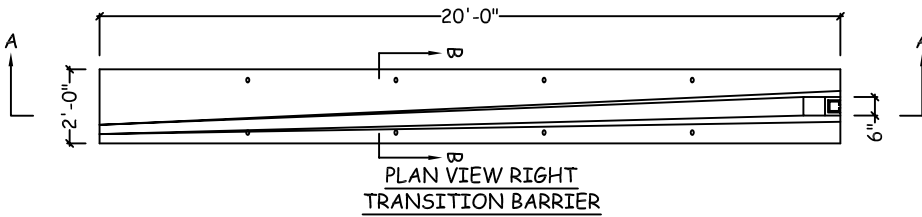

SECTION VIEW 'B' RIGHT TRANSITION BARRIER
 SP-TBR

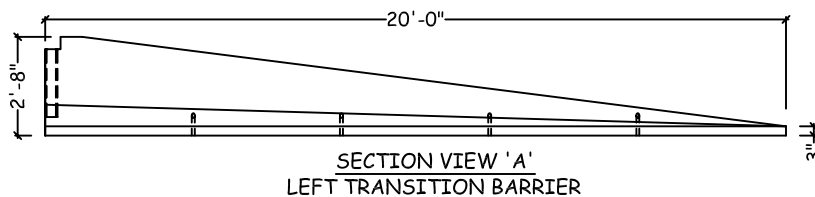
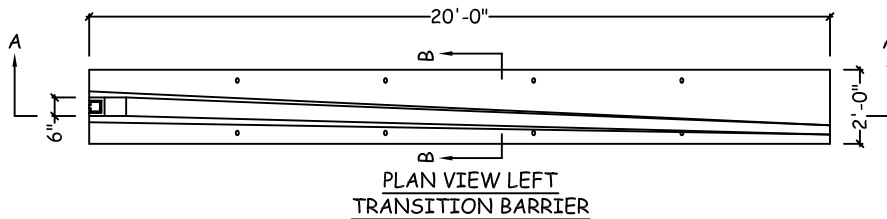

SECTION VIEW 'B' LEFT TRANSITION BARRIER
 SP-TBL